

# VICKERS® SystemStak® Valves



ISO 4401-03; NFPA-D03; 315 bar (4500 psi); 60 L/min (15.7 USgpm)

# Build a Compact, Cost-Effective, Reliable Hydraulic System with Vickers SystemStak™ Valves

## Reduces System Space Requirements

SystemStak valves make compact hydraulic systems in which specific function valves are “sandwich” mounted between a directional valve and a standard mounting surface.

## Reduce Cost

SystemStak valves eliminate intervalve piping and leak-prone tube and pipe connections. Installed cost is less than when using conventional valves.

## Versatile and Easy to Install

SystemStak valves have all the internal passages necessary to serve the directional valve topping them. Mounting surfaces and port patterns are to international standards: any valve conforming to ISO 4401 size 03; ANSI/B93.7M size D03; NFPA-D03; CETOP 3; and DIN 24340, NG6 mounting interface can be used with these SystemStak valves.

## Rugged and Reliable

Internal working parts are produced from hardened steel and mounted in ductile (spheroidal graphite) iron bodies. Excellent reliability is ensured. Working parts are accessible without removing valves from an assembled stack.

## SystemStak Systems... Easy to Understand, Easy to Design

SystemStak circuitry is best shown using slightly different symbols than those for traditional valve configurations. Each SystemStak symbol has the same basic form and size as shown in fig. 1.

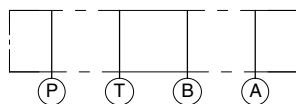

Figure 1

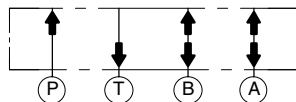

Figure 2

For ease of understanding, remember the directions of flow for each line, and that all four flow paths pass through each valve (see fig. 2). For clarity, directional valves are drawn vertically in SystemStak circuit diagrams (see fig. 3).

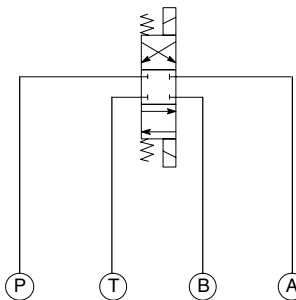

Figure 3

Each station (valve stack) is a combination of functions. When designing and assembling SystemStak valves, care must be taken to ensure that they interact as required by stacking the functions in the correct sequence (fig. 4 is an example).

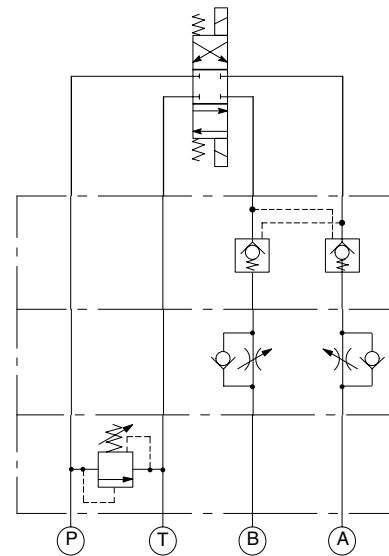

Figure 4

Relief valves should normally be positioned next to the mounting surface (i.e. at the bottom of the stack). When both a flow control and a pilot operated check valve are required, it is recommended that the flow control valve be between the check valve and the actuator to prevent check valve chatter.

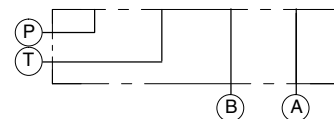

Figure 5

A combination of directional valve, SystemStak valve(s) and subplate/manifold block (fig. 5: single station subplate and fig. 6: multi-station manifold) completes the assembly.

# SystemStak Systems . . . Easy to Understand, Easy to Design

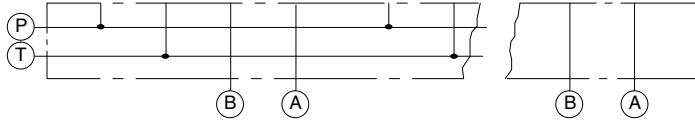

Figure 6

Fig. 7 represents a complete SystemStak system, showing typical use of functions available from this range. The circuit diagram also shows the use of a tapping plate for accessing line pressure readings, and a blanking plate to close off an unused station of a multi-station manifold.

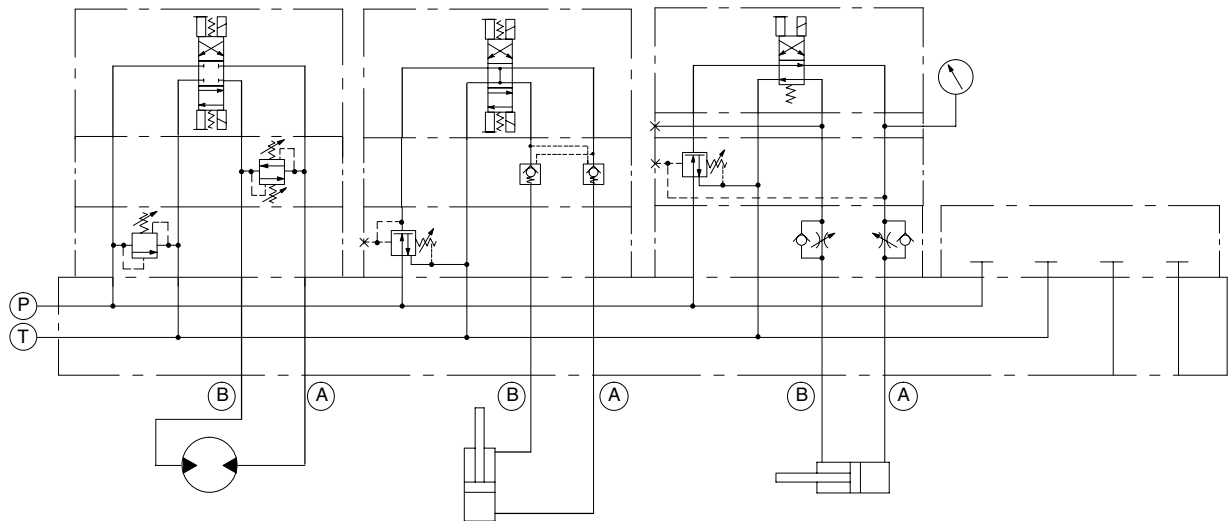

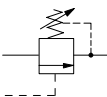
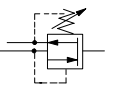
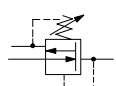

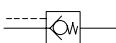
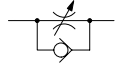

Figure 7

# Table of Contents

Function	Basic symbol	Basic model	Features	Page
Relief		DGMC	Single, dual and crossport models	5
Counterbalance		DGMR	Control in port T	9
Sequence		DGMR1	Single port P sequence	9
Reducing/relieving		DGMX	Piloted from (and reduced pressure in) port P, A or B	9
Direct check		DGMDC	Single check in any port; dual check in ports A and B only	13
Pilot operated check		DGMPC	Single in port A or B; dual in ports A and B	16
Flow restrictor		DGMFN	Single or dual port, meter-in or meter-out	19
Further information: Mounting bolts, subplates and manifold blocks Hydraulic fluids Filtration requirements Temperature limits Pressure drop at other viscosities Types H and K adjusters Warranty and repair Ordering procedure				22

## Operating Data

Maximum flow rate	60 L/min (16 USgpm)
Maximum operating pressure	315 bar (4500 psi)
Pressure drops	See graphs
Mounting position	Optional

### Mass, Approximate:

DGMC	1,3 kg (2.9 lb)
DGMC2	2,5 kg (5.5 lb)
DGMR(1)	1,3 kg (2.9 lb)
DGMX	1,3 kg (2.9 lb)
DGMDC	1 kg (2.2 lb)
DGMPC	0,8 kg (1.8 lb)
DGMFN	1,1 kg (2.2 lb)

# Relief Valves

## DGMC-3-4\*

## DGMC2-3-4\*

### General Description

These two-stage adjustable pressure relief valves limit the maximum pressure in the line(s) controlled by the integral relief valve elements.

Pressure adjustment options of control knob (with or without keylock) or screw/locknut design are available. The two-stage operation is basically identical to long-established balanced piston valves, described in detail in Vickers Industrial hydraulics manual.

### Typical Section

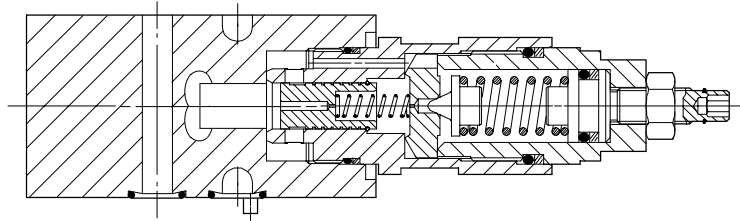

### Functional Symbols

For simplicity these two-stage valves are represented as single-stage models

DGMC-3-PT-\*\*

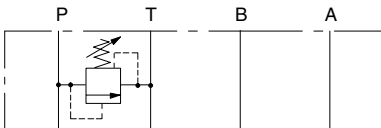

DGMC2-3-AT-\*\*-BT-\*\*

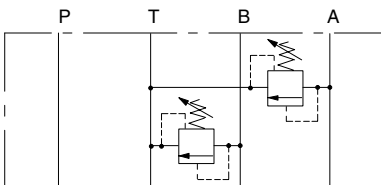

DGMC-3-BA-\*\*

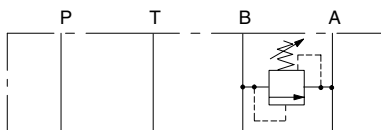

DGMC2-3-AB-\*\*-BA-\*\*

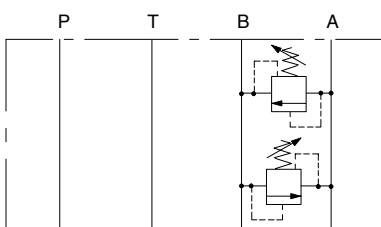

### Model Code for Relief Valves

**DGMC(2)-3- \*\* - \* \* (-B\* - \* \*)- \* - 4\***

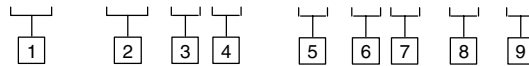

#### 1 Type

2 = Dual relief function  
Omit for single relief function

#### 2 First function

Single relief, or first line of dual models

Code	Pressure limited in	Discharge into	Usage
PT	P	T	Single only
AB	A	B	Single, or dual with BA
BA	B	A	Single only
AT	A	T	Single, or dual with BT
BT	B	T	Single only

#### 3 Pressure adjustment range, first function

A = 3-50 bar (43.5-725 psi)  
B = 3-100 bar (43.5-1450 psi)  
C = 10-200 bar (145-2900 psi)  
G = 50-315 bar (725-4500 psi)

#### 4 Pressure adjustment/ locking method, first function

H = Handknob  
K = Micrometer with keylock  
W = Screw and locknut

# Relief Valves

## DGMC-3-4\*

## DGMC2-3-4\*

### 5 Second function

Second line of dual models

Code	Pressure limited in	Discharge into	Usage
BA	B	A	Dual with AB
BT	B	T	Dual with AT

Omit for single line models

### 6 Pressure adjustment range, second function

Options as in 3

### 7 Pressure adjustment/ locking method, second function

Options as in 4

### 8 Gage port: option on AT and PT single models only

B = G<sup>1</sup>/<sub>4</sub>" (1/<sub>4</sub> BSPF)

S = SAE 4 (7/<sub>16</sub>"-20 UNF-2B)

Blank = No gage port

### 9 Design number, 40 series

Subject to change. Installation dimensions unchanged for design numbers 40 to 49 inclusive.

## Performance Characteristics

Pressure override

Typical performance for PT models at max. pressure settings with mineral oil at 21 cSt (102 SUS) and at 50°C (122°F).

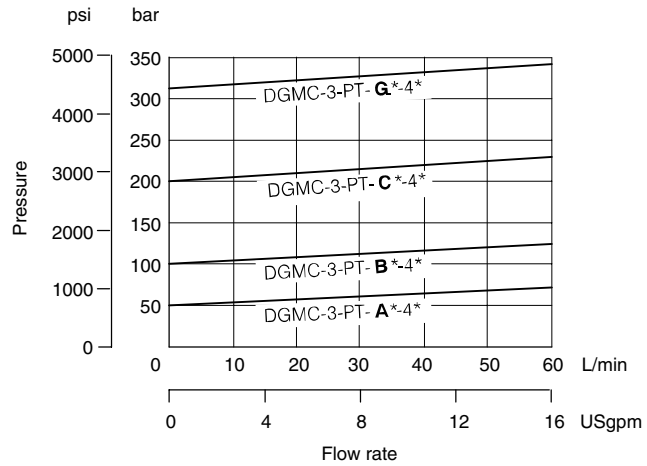

# Installation Dimensions in mm (inches)

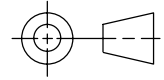

## DGMC(2)-3\*\*-\*\*(-B\*-\*\*-4)\* Models with type W adjuster

To adjust valve setting slacken off locknut and turn adjuster screw. ■  
 ■ Turn clockwise to increase pressure;  
 counter-clockwise to decrease pressure  
 Re-tighten locknut after completing adjustment.

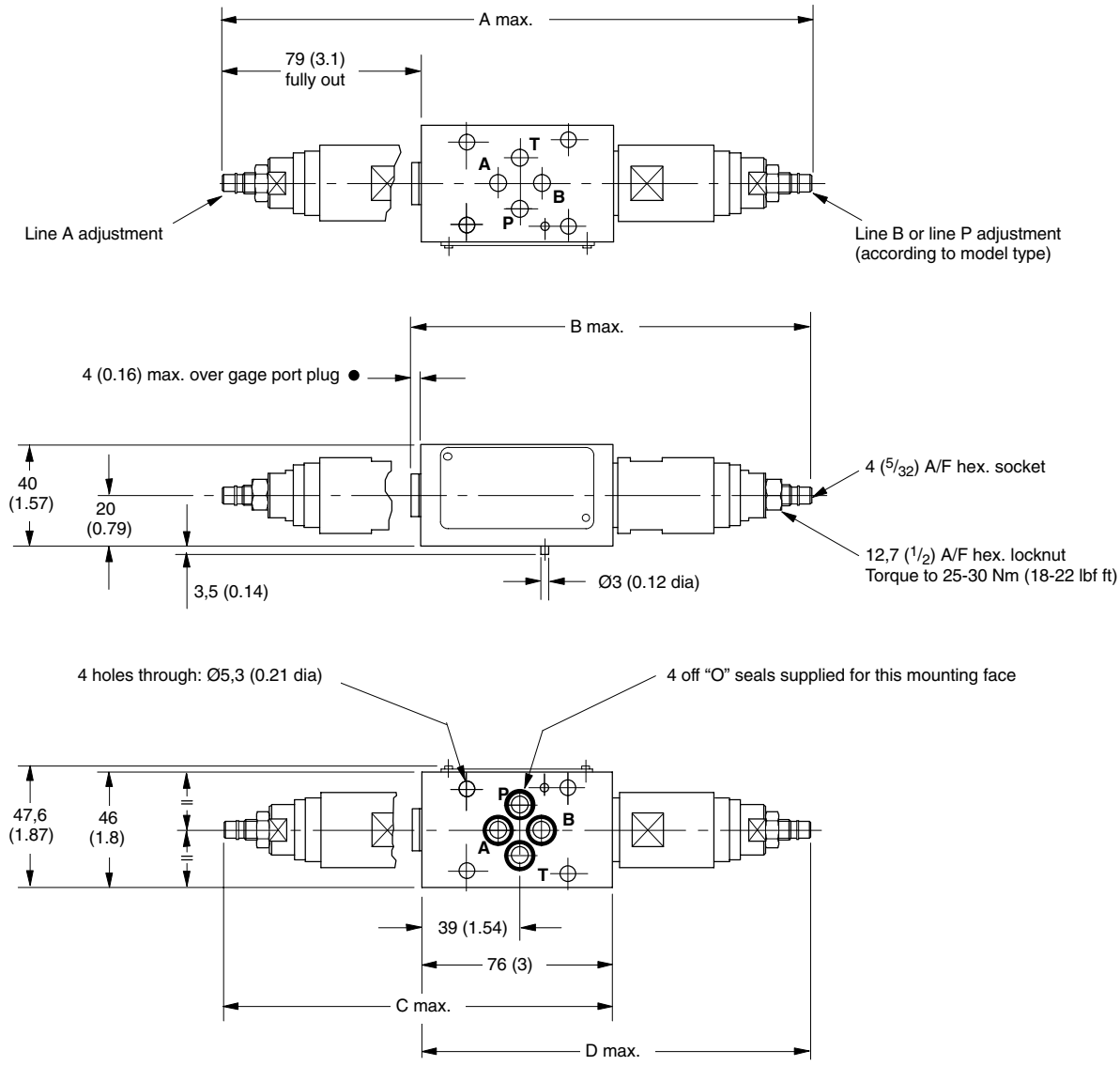

Model	A	B	C	D
DGMC-3-AT-*W-4*	-	-	154 (6.1)	-
DGMC-3-BT-*W-4*	-	-	-	156 (6.2)
DGMC-3-AT-*W-*4*	-	160 (6.3)	-	-
DGMC-3-PT-*W-4*	-	-	-	156 (6.2)
DGMC-3-PT-*W-*4*	-	160 (6.3)	-	-
DGMC2-3-AT-*W-BT-*W-4*	234 (9.2)	-	-	-

● For gage port thread options see model code 8

## Installation Dimensions in mm (inches)

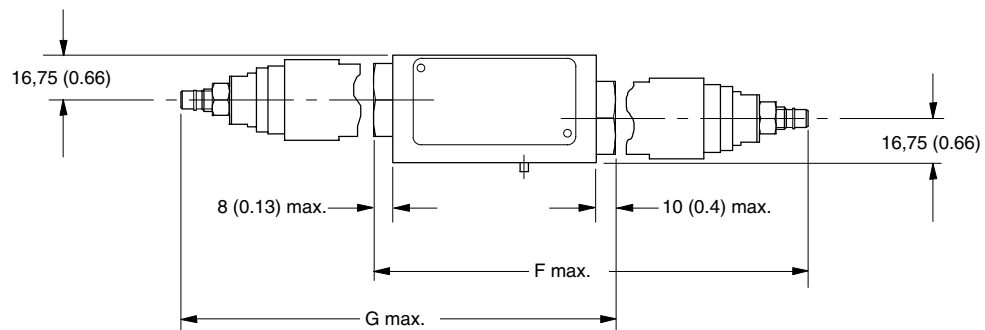
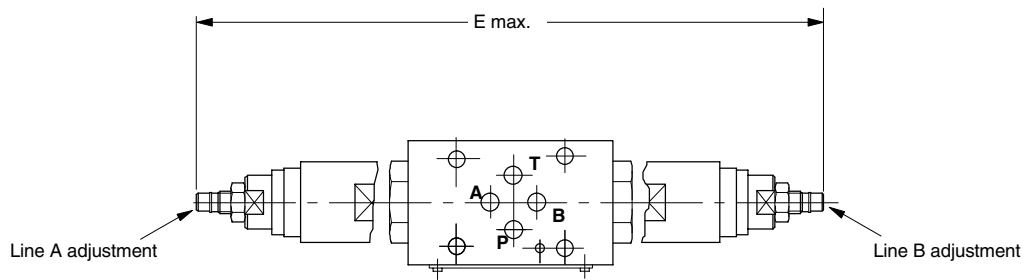

Model	E	F	G
DGMC-3-AB-*W-4*	-	-	164 (6.5)
DGMC-3-BA-*W*-4*	-	164 (6.5)	-
DGMC2-3-AB-*W-BA-*W-4*	234 (9.2)	-	-



# Pressure Controls: Counterbalance, Sequence and Pressure Reducing Valves

## DGMR(1)-3-4\*

## DGMX\*-3-4\*

### General Description

These single-stage valves operate by the application of pressure on the end of the valve spool, acting against a spring which is loaded by means of the adjustment mechanism.

In the counterbalance and sequence valves the spool is offset by the spring such that flow cannot pass through the valve. When the force exerted by the pilot pressure on the spool end exceeds the force of the main spring, the spool is moved to allow flow through the valve.

In the pressure reducing valve the flow path is normally open and is closed as the pilot pressure exceeds the setting of the valve. Excessive pressure in the reduced-pressure line is prevented by a pressure relieving function.

Pressure adjustment options of control knob (with or without keylock) or screw/locknut design are available.

### Typical Section

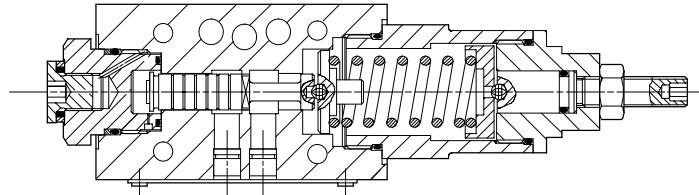

### Functional Symbols

DGMR-3-TA

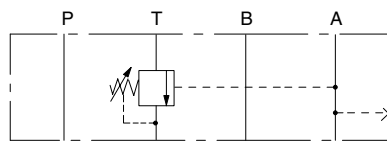

DGMX\*-3-PB

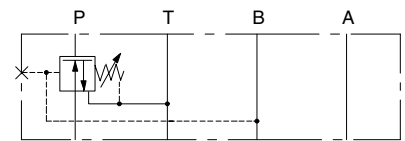

DGMR1-3-PP

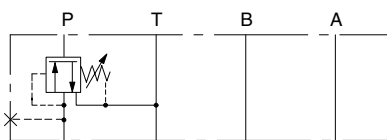

DGMX\*-3-PP

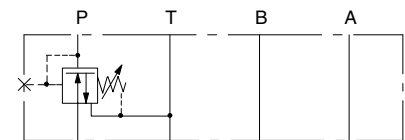

DGMX\*-3-PA

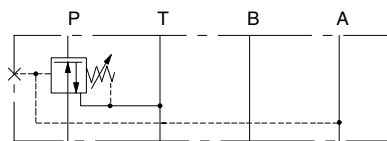

# Model Code for Counterbalance, Sequence and Pressure Reducing Valves

## DGM \*(\*) -3- \*\* (\*)- \* \* - \* - 4\*

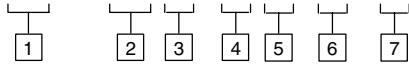

### 1 Type

R = Counterbalance function  
R1 = Sequence function  
X1 = Pressure reducing, underlapped  
X2 = Pressure reducing, overlapped  
X3 = Pressure reducing, overlapped, low leakage

### 2 Function ports

For DGMR only:  
TA = Counterbalance control function in "T" port, controlled by pressure in "A" port  
For DGMR1 only:  
PP = Sequence control in "P" port, controlled by pressure in "P" port  
For DGMX only:  
PA = Pressure reducing function in line P, piloted from A  
PB = Pressure reducing function in line P, piloted from B  
PP = Pressure reducing function in line P, piloted from P

### 3 Adjuster location

Option on DGMX only  
L = Adjuster at "A"-port end of valve  
Blank = Adjuster at "B"-port end of valve

### 4 Pressure adjustment range

For DGMX only:  
Y = 1,40-7,0 bar (21-101 psi)  
R = 1,40-45,0 bar (21-652 psi)  
For DGMR and DGMX:  
A = 3-30 bar (43.5-435 psi)  
B = 3,5-70 bar (51-1000 psi)  
C = 10-140 bar (145-2000 psi)  
F = 20-250 bar (290-3625 psi)

### 5 Pressure adjustment/ locking method

H = Handknob  
K = Micrometer with keylock  
W = Screw and locknut

### 6 Gage port

B = G<sup>1/8"</sup> (1/8 BSPF)  
S = SAE 4 (7/16"-20 UNF-2B)

### 7 Design number, 40 series

Subject to change. Installation dimensions unchanged for design numbers 40 to 49 inclusive.

# Performance Characteristics

Typical performance with mineral oil at 21 cSt (102 SUS) and at 50°C (122°F).

## DGMX\*-3-P\*

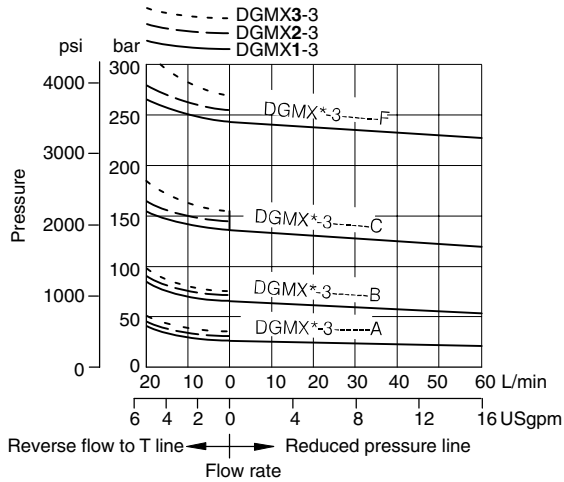

## DGMR1-3-PP

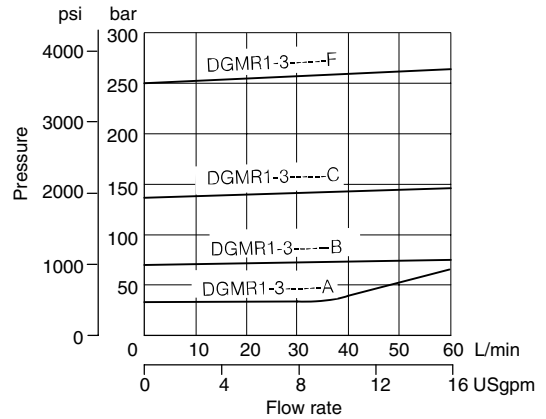

## DGMX\*-3-P\*

### Low Pressure/Flow Rate Minimum Performance

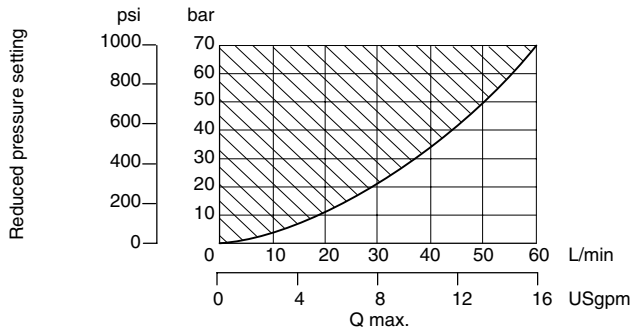

### Effect of Back-Pressure

The effective reduced pressure is equal to the valve adjustment setting plus any back-pressure in line T

### Dead Head Leakage

Typical leakage flow at 250 bar inlet pressure from reduced pressure line into T at "Dead Head" condition (i.e. No flow required at the reduced pressure outlet.)

This leakage flow must be provided at the inlet line P in order to maintain the reduced outlet pressure.

DGMX1-3 = 1600

DGMX2-3 = 400

DGMX3-3 = 80

# Installation Dimensions in mm (inches)

**DGMR-3-TA-\*\*-\*-4\***  
**DGMR1-3-PP-\*\*-\*-4\***  
**DGMX(\*)-3-P\*(L)-\*\*-\*-4\***

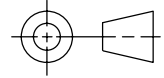

## Models with type W adjuster

To adjust valve setting slacken off locknut and turn adjuster screw ■

■ Turn clockwise to increase pressure;  
 counter-clockwise to decrease pressure.

Re-tighten locknut after completing adjustment.

DGMX2-3-\*\*L models have adjuster and end cap/gage port locations interchanged from positions shown.

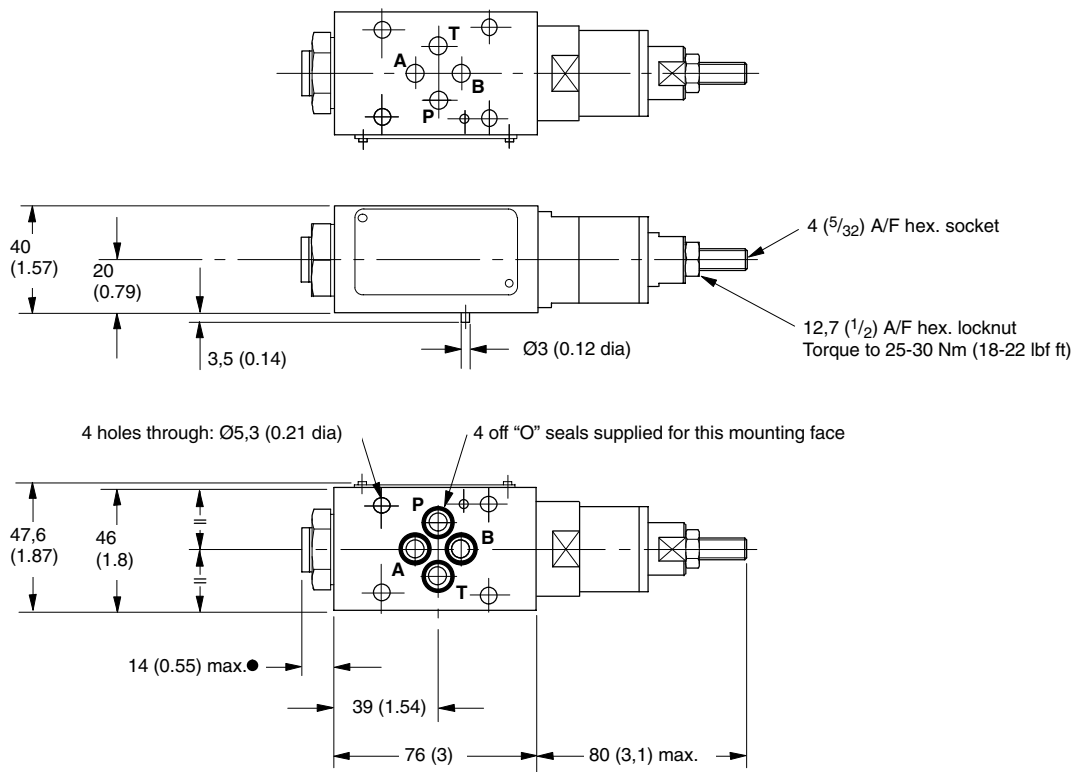

● For gage port thread options see model code [6],  
 (pressure plug fitted)

# Direct Check Valves DGMDC-3-4\*

## General Description

These valves allow free flow in one direction in the line in which the check valve element(s) is (are) located; flow in the opposite direction is not possible.

## Functional Symbols

DGMDC-3-X-A\*

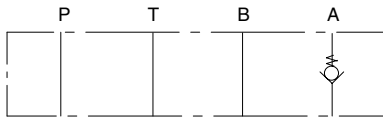

DGMDC-3-Y-A\*

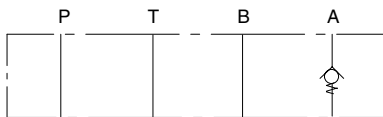

DGMDC-3-X-B\*

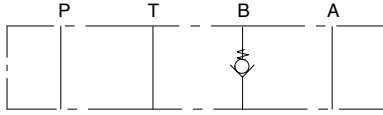

DGMDC-3-Y-B\*

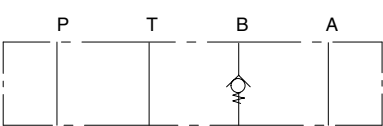

DGMDC-3-Y-P\*

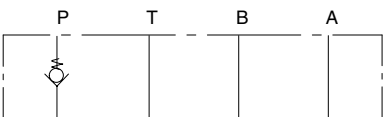

DGMDC-3-X-T\*

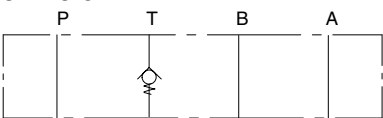

DGMDC-3-Y-A\*-B\*

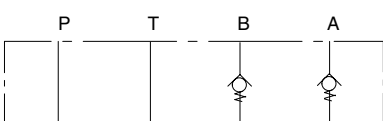

## Typical Section

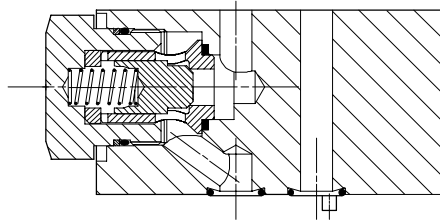

## Model Code for Direct Check Valves

**DGMDC-3- \* - \* \* (- \* \* )-4\***

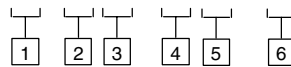

### 1 Direction of flow

X = Free flow away from actuator

Y = Free flow towards actuator

### 2 Check location

A = A line

B = B line

P = P line; with Y in 1

T = T line; with X in 1

### 3 Check valve opening/cracking pressure

K = 1 bar (14.5 psi)

M = 2,5 bar (36 psi)

N = 5 bar (72 psi)

### 4 Check location (second element of dual model)

Only available as model type

DGMDC-3-Y-A\*-B\*-4\*

B = B line

### 5 Check valve opening/cracking pressure (second function of dual model)

Options as in 3

### 6 Design number, 40 series

Subject to change. Installation dimensions unchanged for design numbers 40 to 49 inclusive.

# Performance Characteristics

Typical performance with mineral oil at 21 cSt (102 SUS) and at 50°C(122°F) ●

Pressure drop: free flow through check valve

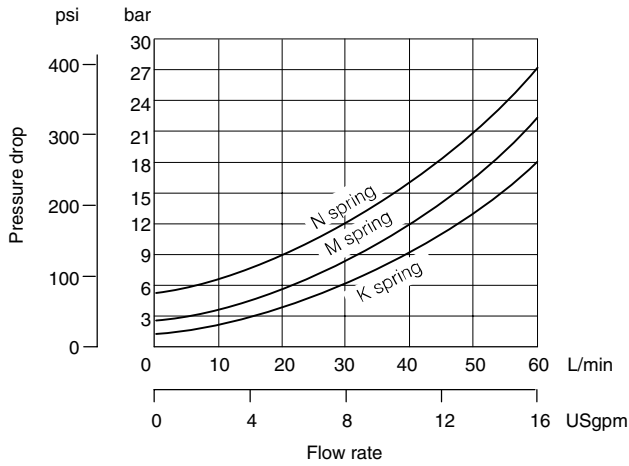

● For other viscosities, see "Further Information".

## Internal Leakage Across Closed Check Valve

Less than 0,25 ml/min (0.015 in<sup>3</sup>/min) at 250 bar (3625 psi)

# Installation Dimensions in mm (inches)

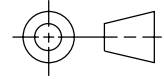

**DGMDC-3-Y-A\*-B\*-4\***

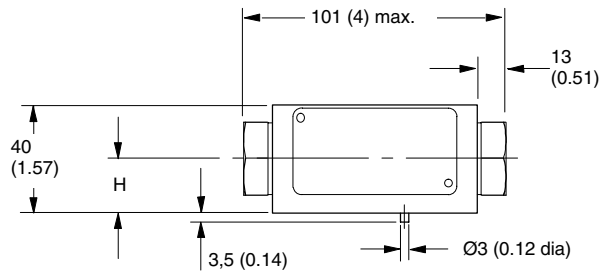
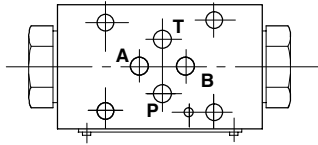

**DGMDC-3-X-A\*-4\***  
**DGMDC-3-X-T\*-4\***  
**DGMDC-3-Y-A\*-4\***  
**DGMDC-3-Y-P\*-4\***

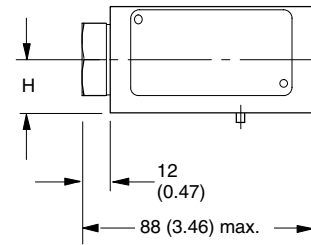
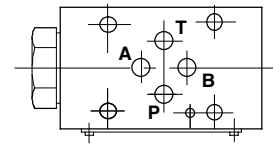

4 holes through: Ø5,3 (0.21 dia)

4 off "O" seals supplied for this mounting face

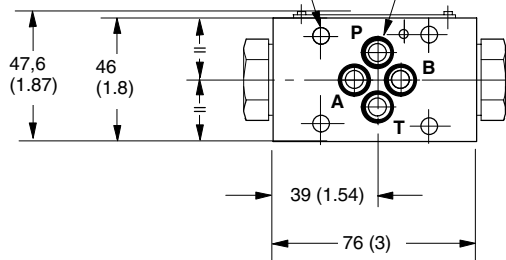

**DGMDC-3-X-B\*-4\***  
**DGMDC-3-Y-B\*-4\***

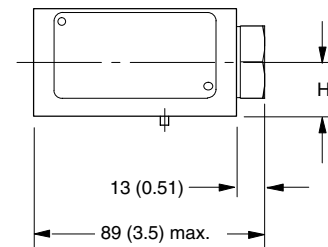

Model type	H
DGMDC-3-X-A*-4*	16,75
DGMDC-3-X-B*-4*	(0.66)
DGMDC-3-Y-P*-4*	
DGMDC-3-X-T*-4*	23,25
DGMDC-3-Y-A*-4*	(0.92)
DGMDC-3-Y-B*-4*	
DGMDC-3-Y-A*-B*-4*	

# Pilot Operated Check Valves DGMPC-3-4\*

## General Description

These valves provide pilot operated check functions in one or both service lines (A or B), the operating pilot supply coming from the opposite service line. Thus with pressure in one service line the check valve in the other service line will be open (subject to system/actuator pressures being correct for the valve area ratios).

A 3:1 area ratio of pilot piston to check valve seat is supplemented by an optional 10:1 decompression feature.

## Typical Section

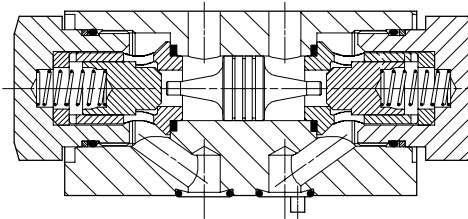

## Functional Symbols

DGMPC-3-(D)AB\*-(D)BA\*

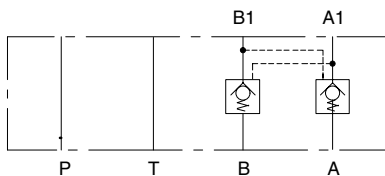

DGMPC-3-(D)AB\*

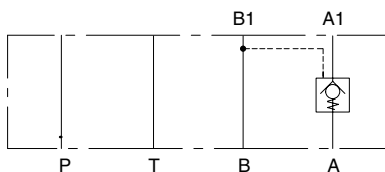

DGMPC-3-(D)BA\*

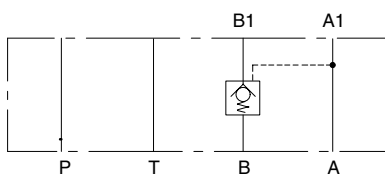

## Model Code for Pilot Operated Check Valves DGMPC-3-(D)\*\* \* [- (D)\*\*\*] - 4\*

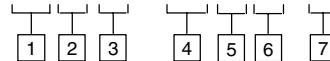

**1 Decompression feature**  
D = 10:1 decompression ratio  
Omit if not required

**2 Function**  
AB = Check in line A, pilot operated from line B  
BA = Check in line B, pilot operated from line A (single check model only)

**3 Check valve opening/cracking pressure**  
K = 1 bar (14.5 psi)  
M = 2,5 bar (36 psi)  
N = 5 bar (72 psi)

**4 Decompression feature (second function of dual models)**  
As in **1**  
Omit for single line models, and if not required for dual models

*Note: "D" must be specified here, for dual models, if called for in **1***

**5 Second function of dual models**  
BA = Check in line B, pilot operated from line A  
Omit for single line models

**6 Check valve opening/cracking pressure (second function of dual models)**  
Options as in **3**  
Omit for single line models

**7 Design number, 40 series**  
Subject to change. Installation dimensions unchanged for design numbers 40 to 49 inclusive.



# Performance Characteristics

## Pressure Drop Data

Typical performance with mineral oil at 21 cSt (102 SUS) and at 50°C(122°F) u

Pressure drop: flow path A1 to A or B1 to B (no pilot-pressure operation)

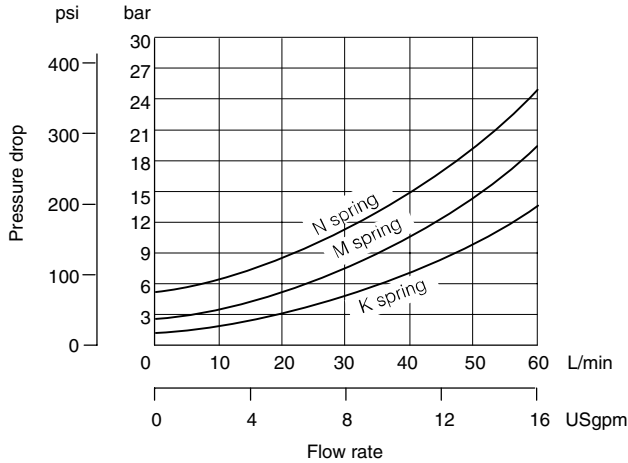

Pressure drop: flow path A to A1, or B to B1 with check valve pilot-operated fully open

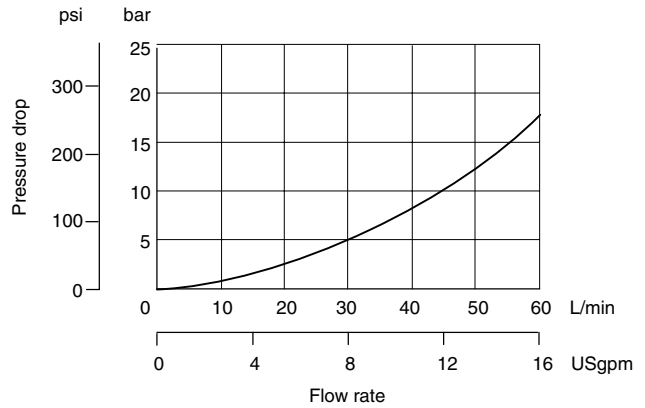

u For other viscosities see "Further Information".

## Pilot Pressures

Pilot area ratios:

Main check valve ..... 3:1

Decompression poppet ..... 10:1

Use applicable ratio and opening/cracking pressure to calculate pilot pressure to open valve element, applied to the following formulae:

To open valve or decompression poppet in line A:

$$\text{Pressure at B1} = \frac{p_A + p_C - p_{A1}}{\text{Area ratio factor}} + p_{A1}$$

To open valve or decompression poppet in line B:

$$\text{Pressure at A1} = \frac{p_B + p_C - p_{B1}}{\text{Area ratio factor}} + p_{B1}$$

Where:

$p_A$  = Pressure at A

$p_C$  = Cracking/opening pressure

$p_{A1}$  = Pressure at A1

$p_B$  = Pressure at B

$p_{B1}$  = Pressure at B1

A = }  
 B = } Service line location;  
 A1= } see functional symbols  
 B1= }

## Leakage

Less than 0,25 ml/min (0.015 in<sup>3</sup>/min) at 250 bar (3625 psi).

# Installation Dimensions in mm (inches)

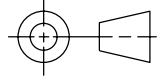

**DGMPC-3-(D)AB\*-(D)BA\*-4\***

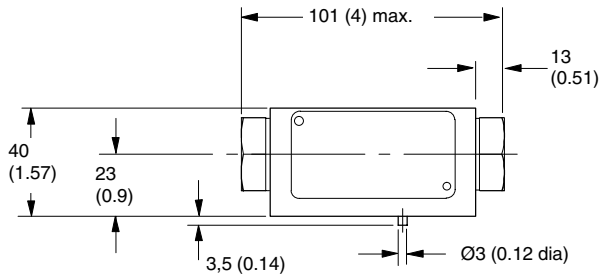
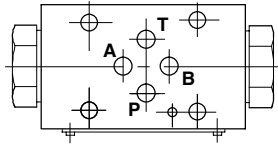

**DGMPC-3-(D)AB\*-4\***

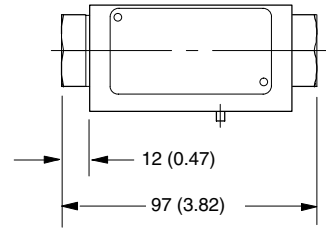
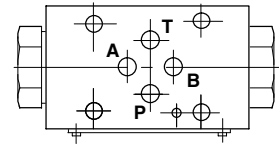

4 holes through: Ø5,3 (0.21 dia)

4 off "O" seals supplied for this mounting face

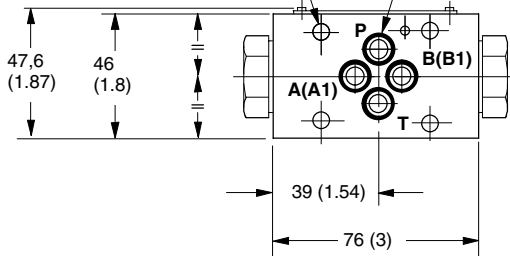

**DGMPC-3-(D)BA\*-4\***

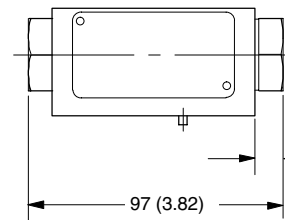

# Flow Restrictor Valves DGMFN-3-4\*

## General Description

These valves regulate flow by means of an adjustable orifice which is not pressure compensated, and flow through the valve is entirely dependent upon pressure drop at any particular setting of the orifice.

Dual service-line models with an integral non-return valve around each control orifice provide for meter-in or meter-out control; single line versions of these are available.

For flow restriction in P or T lines (where reverse free flow is not required) models without check valves are available.

Adjustment options are either screw/locknut or handknob.

## Typical Section

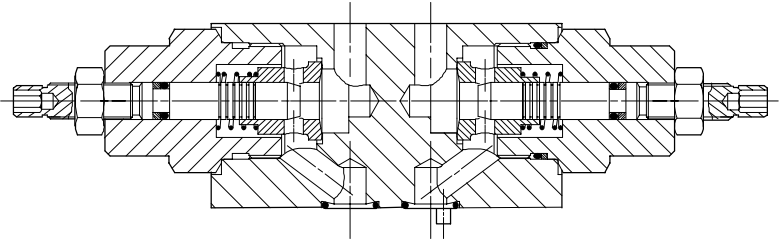

## Model Code for Flow Restrictor Valves

**DGMFN-3- \* - \* \* \* (- \* \* \* )-4\***

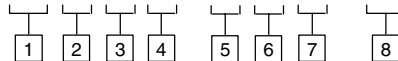

## Functional Symbols

DGMFN-3-X-A\*\*-B\*\*

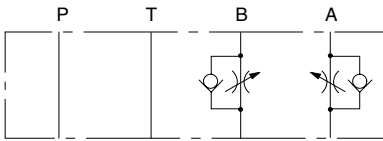

DGMFN-3-Y-A\*\*-B\*\*

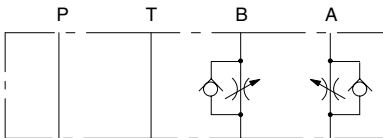

DGMFN-3-Z-P\*\*

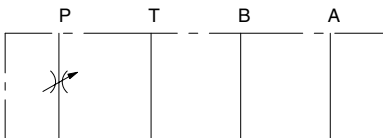

DGMFN-3-Z-T\*\*

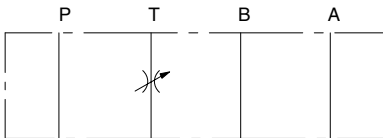

### 1 Direction of flow control (with respect to machine actuator)

X = Meter-in control, applicable to lines A and B

Y = Meter-out control, applicable to lines A and B

Z = Meter-in control, line P only and meter-out control, line T only.

### 2 Location of control function (single model or first line of dual model)

P = Line P (single model only)

T = Line T (single model only)

A = Line A (single model or first line of dual model)

B = Line B (single model only)

### 3 Type of control needle/orifice (single model or first line of dual model)

1 = Fine control

2 = Standard control

### 4 Adjuster type (single model or first line of dual model)

H = Handknob

W = Screw/locknut

### 5 Control in second line

B = Line B (use for dual models with "A" specified at 2)

Omit for single models

### 6 Type of control needle/orifice (second line of dual models)

Options as in 3

Omit for single models

### 7 Adjuster type (second line of dual models)

Options as in 4

Omit for single models

### 8 Design number, 40 series

Subject to change. Installation dimensions unaltered for design numbers 40 to 49 inclusive.

# Performance Characteristics

## Pressure Drop

Typical performance with mineral oil at 21 cSt (102 SUS) and at 50°C(122°F)●

Type "1" needle (see model codes 3 and 6 )

Type "2" needle (see model codes 3 and 6 )

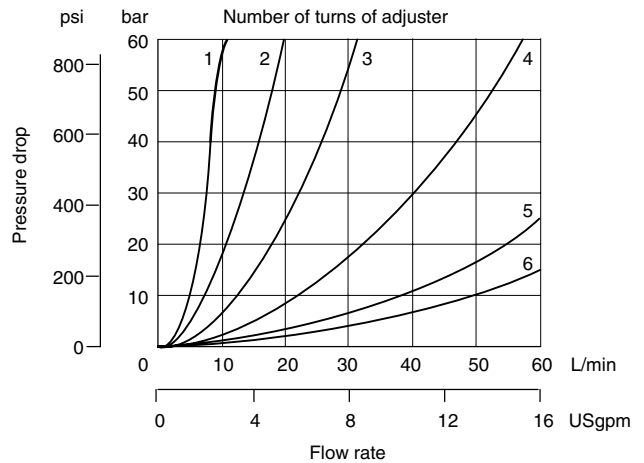
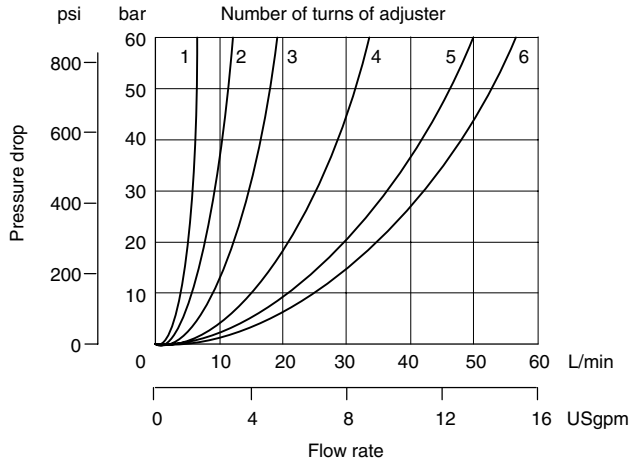

## Free flow through check valve

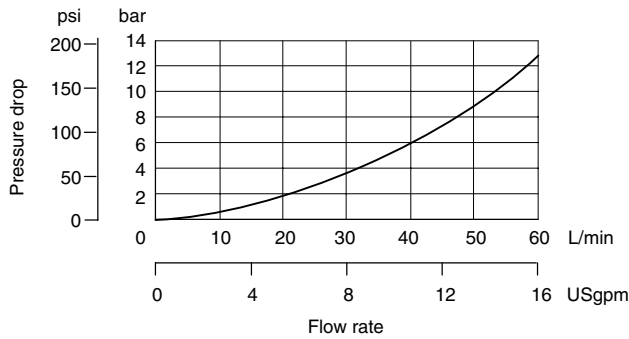

● For other viscosities see "Further Information".

# Installation Dimensions in mm (inches)

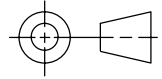

**DGMFN-3-X-\*\*\*(-\*\*\*)-4\***  
**DGMFN-3-Y-\*\*\*(-\*\*\*)-4\***  
**DGMFN-3-Z-\*\*\*-4\***

## Models with type W adjuster

To adjust valve setting, slacken off locknut and turn screw. Re-tighten locknut after completing adjustment.

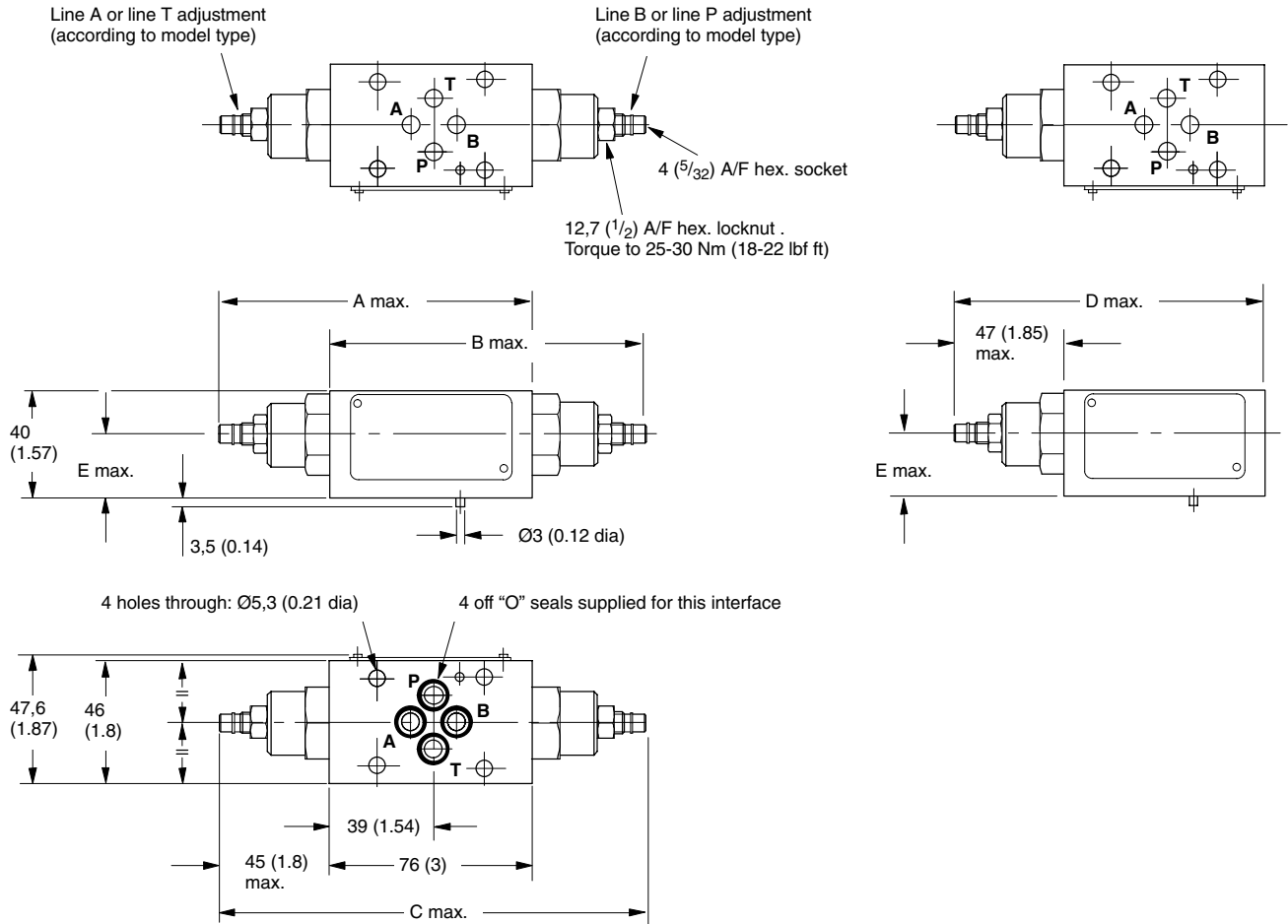

## Type H adjuster

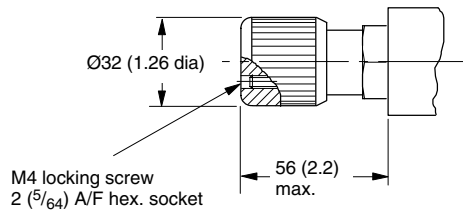

■ Turn clockwise to decrease flow (increase restriction); counter-clockwise to increase flow (reduce restriction).

Model	A	B	C	D	E
DGMFN-3-X-A*W-4*	121 (4.76)	–	–	–	16,75 (0.7)
DGMFN-3-X-A*W-B*W-4*	–	–	167 (6.6)	–	16,75 (0.7)
DGMFN-3-X-B*W-4*	–	122 (4.8)	–	–	16,75 (0.7)
DGMFN-3-Y-A*W-4*	121 (4.76)	–	–	–	23,25 (0.9)
DGMFN-3-Y-A*W-B*W-4*	–	–	167 (6.6)	–	23,25 (0.9)
DGMFN-3-Y-B*W-4*	–	122 (4.8)	–	–	23,25 (0.9)
DGMFN-3-Z-P*W-4*	–	–	–	123 (4.8)	16,75 (0.7)
DGMFN-3-Z-T*W-4*	–	–	–	123 (4.8)	23,25 (0.9)

## Further Information

### Mounting Bolts, Subplates and Manifold Blocks

#### Mounting Bolts

The length of mounting bolt used to install a SystemStak assembly is dependent on the number of valves being used, plus the length needed for mounting other valves in the assembly, such as:

- solenoid operated, or other type of directional valve
- tapping plate
- blanking or crossover plate.

Vickers offers a large selection of bolt kits (one bolt kit for these SystemStak valves comprises 4 bolts) in metric and inch sizes as listed. To determine your needs, use the following guide for bolt length calculation.

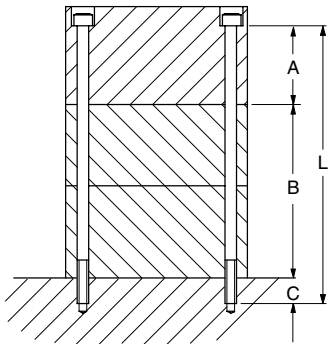

- A = Bolt clamp length in directional valve, blanking plate, crossover plate, etc.
- B = Height of intermediate valve stack, comprising Vickers SystemStak valve(s) plus tapping plates, etc.
- C = Depth of thread engagement in sub-plate/manifold block:  
8/10 mm (0.3/0.4"), valid for:  
315 bar (4500 psi) when using cast iron or steel subplates/manifold blocks, or 210 bar (3045 psi) when using Vickers aluminium alloy manifold blocks.
- L = Required bolt length; select from the table.

#### Notes

1. Bolts should be torqued to 7-9 Nm (63-80 lbf in) with threads lubricated.
2. If not using Vickers bolt kits, bolts must be to Grade 12.9 (ISO 898) or better.

#### Bolt Kit Selection

Metric: M5-6g		Inch: 10-24 UNC-3A	
Length (mm)	Vickers bolt kit number	Length (in)	Vickers bolt kit number
50	BKDG3699M	2.0	BKDG3698
60	BK466836M	2.375	BK466849
70	BK464125M	2.75	BK870017
80	BK466837M	3.125	BK466850
90	BK466838M	3.5	BK466851
100	BK466839M	3.937	BK466852
110	BK466840M	4.312	BK466853
120	BK466841M	4.75	BK466854
130	BK466842M	5.125	BK466855
140	BK466843M	5.5	BK466856
150	BK466844M	5.937	BK466857
160	BK466845M	6.312	BK466858
170	BK466846M	6.687	BK466859

#### Subplates and Manifold Blocks

See "Subplates and Auxiliary Connection Plates" catalog 2425.

#### Hydraulic Fluids

Materials and seals used in these valves are compatible with :

- Anti-wear petroleum oils . . . . . L-HM
- Water glycols . . . . . L-HFC
- Invert emulsions . . . . . L-HFB
- Non-alkyl based phosphate esters . . . . . L-HFD

The extreme operating range is 500 to 13 cSt (270 to 70 SUS) but the recommended running range is 54 to 13 cSt (245 to 70 SUS). For further technical information about fluids see 694.

#### Filtration Requirements

Recommendations on filtration methods and the selection of products to control fluid condition are included in Vickers publication 561 or 9132. For products in this catalog the recommended fluid cleanliness levels are:

- Up to 210 bar (3050 psi) . . . . . 18/16/13
- Above 210 bar (3050 psi) . . . . . 17/15/12

#### Temperature Limits

Ambient range . . . . . -20°C to +80°C  
(-4°F to +176°F)

#### Fluid temperatures

	Petroleum oil	Water-containing
Min.	-20°C (-4°F)	+10°C (+50°F)
Max.*	+80°C (+176°F)	+54°C (+129°F)

\* To obtain optimum service life from both fluid and hydraulic system, 65°C (150°F) is the recommended maximum fluid temperature, except for water-containing fluids.

For other fluids where limits are outside those of petroleum oil, consult fluid manufacturer or Vickers representative. Whatever the actual temperature range, ensure that viscosities stay within those specified under "Hydraulic Fluids".

## Further Information

### Pressure Drop at Other Viscosities

Published pressure drop data is valid for a fluid viscosity of 21 cSt (102 SUS). The graph shows the approximate percentage change in pressure drop for a range of other viscosities. To determine the approximate pressure drop for any given fluid viscosity, multiply the published data by the % factor for the required viscosity.

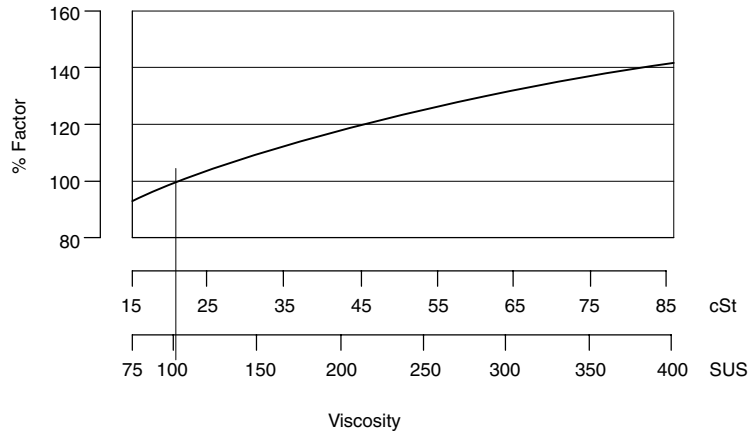

### Type H Adjuster

To adjust valve setting, slacken M4 locking screw and rotate knob . Re-tighten locking screw after completing adjustment.

Available on  
 DGMC-3  
 DGMR-3  
 DGMX-3

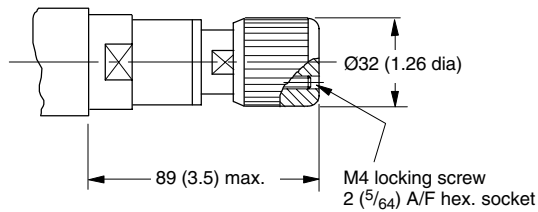

### Type K Adjuster

Key must be inserted and turned to allow valve to be adjusted . When key is removed, adjustment mechanism can be freely turned without changing valve setting.

Available on  
 DGMC-3  
 DGMR-3  
 DGMX-3

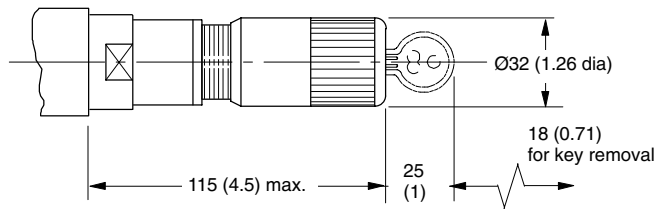

Turn clockwise to increase pressure;  
 counter-clockwise to decrease pressure

## Spare Parts

Valves are sold complete with all seals. Part numbers for available spare seal kits:

DGMC-3-40/41	870738
DGMC2-3-40/41	870737
DGMR(1)-3-40/41	870739
DGMX(*)-3-40/41	870739
DGMDC-3-40/41	870708
DGMPC-3-40/41	870708
DGMFN-3-40/41	870707

Note: Seal kits cover various model options for the respective types. Redundant seals will be found for some models.

## Warranty and Repair

Units to be returned under warranty should be sent, with a description of the fault, to the Vickers representative in your area.

Repair of these size 03 valves is not generally economically viable. Contact your nearest Vickers representative before returning any unit for repair.

## Ordering Procedure

Specify requirements by valve model code, and by seal kit number.