

ACRON

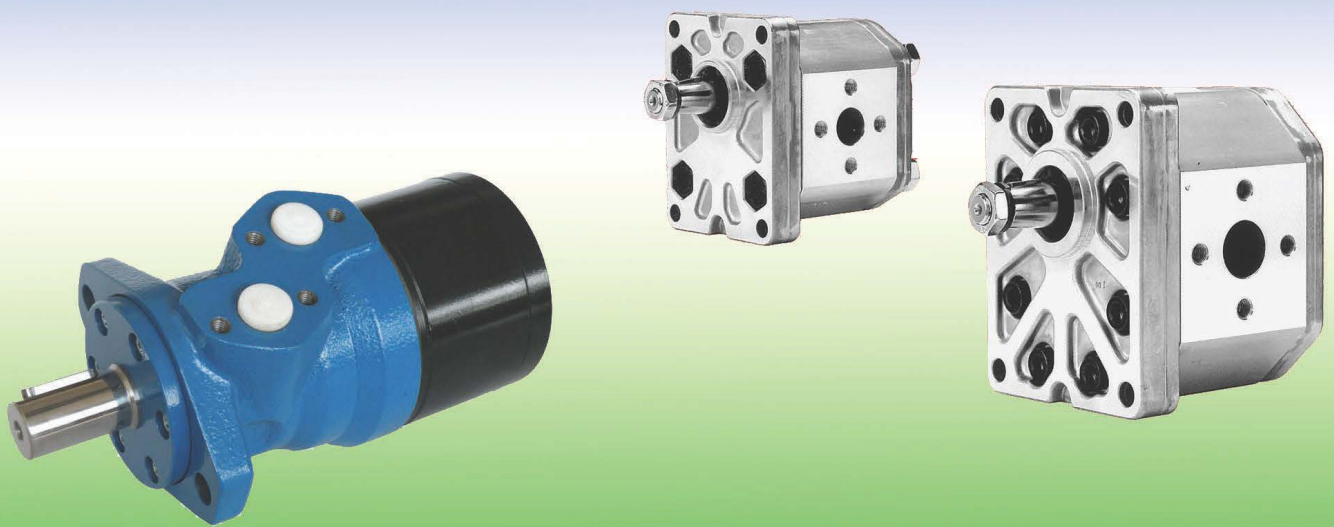

**GEAR PUMPS
HYDRAULIC MOTORS**

HYDRAULIC MOTORS type **ABMR**

ACRON

Pricelist 2013

- Hydraulic orbital motors low speed-high torque
- Suitable for hydraulic oils according to ISO 6743/4
- Recommended viscosity from 20cSt to 100cSt (permissible from 10cSt to 800cSt)
- Temperature range: -15°C to 80°C
- Recommended fluid contamination: 18/16/14 according to ISO 4406/99
- Produced in European Community, under ISO 9001:2000 Quality System



Code	Displacement (cm ³ /rev)	rpm _{max}	P _{max} rated (bar)	P _{max} intermittent (bar)	Output torque at P rated (Nm)	A	B	PRICE (5-9 pcs)	PRICE (10-20 pcs)
ABMR-50	50	970	140	175	100	140,5	8,5	€82,00	€77,00
ABMR-80	80	940	175	200	200	145,3	13,3	€85,00	€79,00
ABMR-100	100	750	175	200	240	148,5	16,5	€87,00	€81,00
ABMR-125	125	600	175	200	300	152,7	20,7	€88,00	€82,00
ABMR-160	160	470	175	200	390	158,4	26,4	€90,00	€84,00
ABMR-200	200	375	140	175	385	165	33	€93,00	€87,00
ABMR-250	250	300	110	140	390	173,3	41,3	€96,00	€89,00
ABMR-315	315	240	85	115	360	184	52	€99,00	€93,00
ABMR-375	375	200	65	90	380	193,5	61,5	€101,00	€95,00

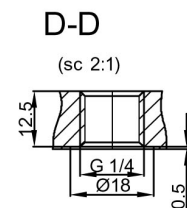
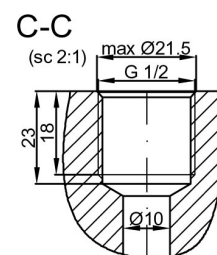
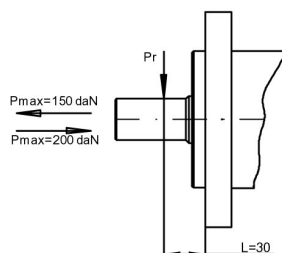
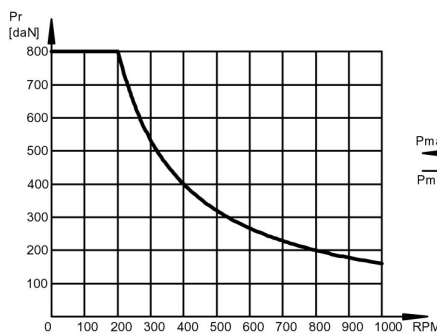
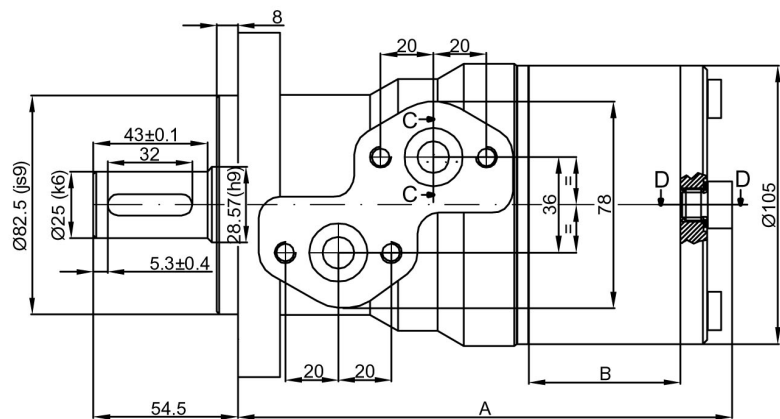
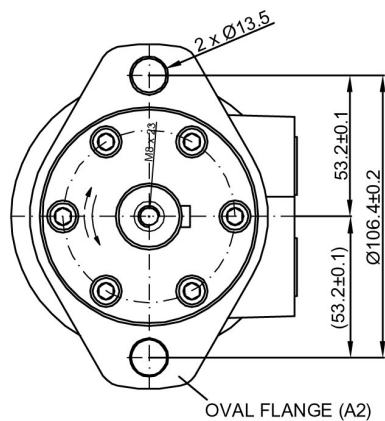

Distributed by

abco
COMPONENTS FOR HYDRAULICS

ITALY - 21013 Gallarate (VA) - Via Olanda, 5 - Tel+39 02 66015524 Fax+39 02 99984600 - email: info@abco.it web: www.abco.it

GEAR PUMPS type AB

ACRON

Pricelist 2013

- Fixed displacement, external gear pumps
- Body in aluminium, plates in aluminium
- Clockwise rotation (counter-clockwise on request)
- Suitable for hydraulic oils according to ISO 6743/4
- Recommended viscosity from 20cSt to 100cSt (permissible from 10cSt to 800cSt)
- Temperature range: -15°C to 80°C
- Recommended fluid contamination: 18/16/14 according to ISO 4406/99
- Produced in European Community, under ISO 9001:2000 Quality System



GROUP 1	Displacement (cm ³ /rev)	P _{max} (bar)	Power (kW) (1500rpm and P _{max})	rpm _{max}	PRICE (5-9 pcs)	PRICE (10-20 pcs)
AB1-2R	1,7	250	1,1	4500	€ 42,50	€ 39,00
AB1-3R	2,2	250	1,4	3500	€ 42,50	€ 39,00
AB1-4R	3,2	250	2,1	3200	€ 42,50	€ 39,00
AB1-5R	3,8	250	2,5	2800	€ 43,30	€ 39,80
AB1-6R	4,3	250	2,8	2700	€ 43,30	€ 39,80
AB1-9R	6,0	190	3,0	2000	€ 43,30	€ 39,80

GROUP 2	Displacement (cm ³ /rev)	P _{max} (bar)	Power (kW) (1500rpm and P _{max})	rpm _{max}	PRICE (5-9 pcs)	PRICE (10-20 pcs)
AB2-10R	6,3	250	4,1	4000	€ 55,00	€ 49,50
AB2-12R	8,2	250	5,4	3500	€ 55,00	€ 49,50
AB2-16R	11,3	250	7,4	3500	€ 55,00	€ 49,50
AB2-20R	14	250	8	3000	€ 55,00	€ 49,50
AB2-24R	16	235	9,5	3000	€ 55,00	€ 49,50
AB2-30R	19	200	10	3000	€ 55,00	€ 49,50
AB2-40R	27,9	140	11,2	2000	€ 55,00	€ 49,50

GROUP 3	Displacement (cm ³ /rev)	P _{max} (bar)	Power (kW) (1500rpm and P _{max})	rpm _{max}	PRICE (5-9 pcs)	PRICE (10-20 pcs)
AB3-33R	22,5	210	13	2800	€ 86,00	€ 79,50
AB3-40R	28	210	16	2800	€ 86,00	€ 79,50
AB3-50R	32,7	210	18	2800	€ 86,00	€ 79,50
AB3-60R	38	210	21	2600	€ 86,00	€ 79,50
AB3-75R	50	180	24	2400	€ 86,00	€ 79,50

100pcs or more, of one single code, will grant you, on this code only, a further discount of 5%

Distributed by

abco
COMPONENTS FOR HYDRAULICS

ITALY - 21013 Gallarate (VA) - Via Olanda, 5 - Tel+39 02 66015524 Fax+39 02 99984600 - email: info@abco.it web: www.abco.it

